

C8065 SCREWDRIVER CAM LATCH

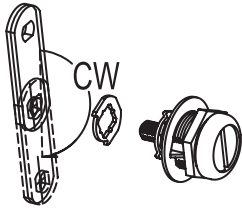

DRAWER

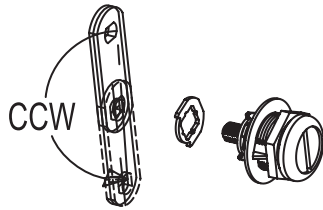

DRAWER

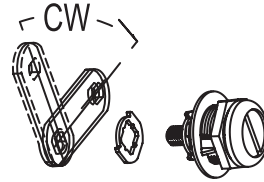

DRAWER

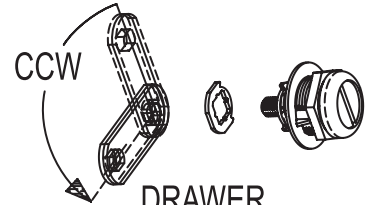

DRAWER

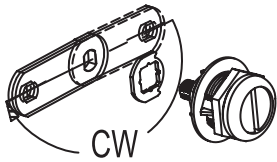

LH DRAWER

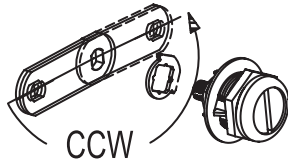

RH DRAWER

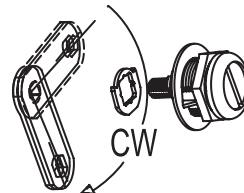

LH DRAWER

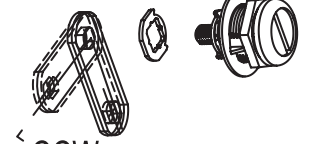

DRAWER

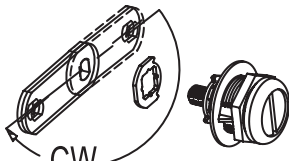

RH DRAWER

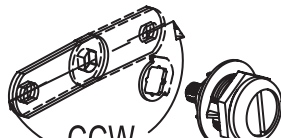

LH DRAWER

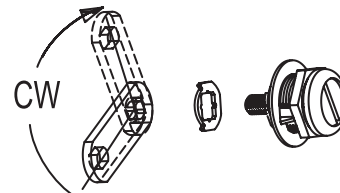

LH DRAWER

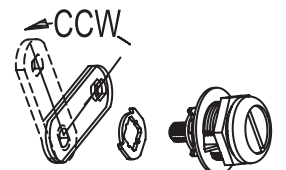

RH DRAWER

METAL

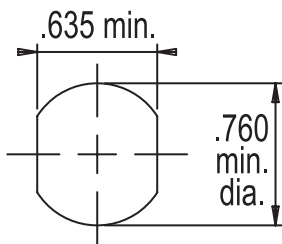

Mounting hole

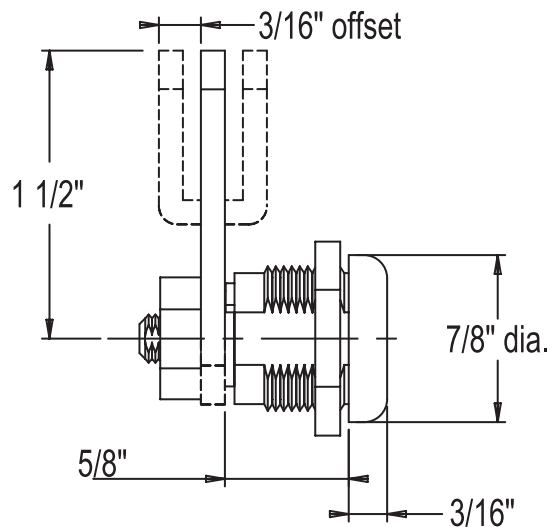

WOOD

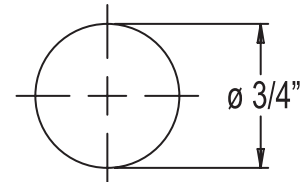

Mounting hole