

MFW 29138 CAM LOCK

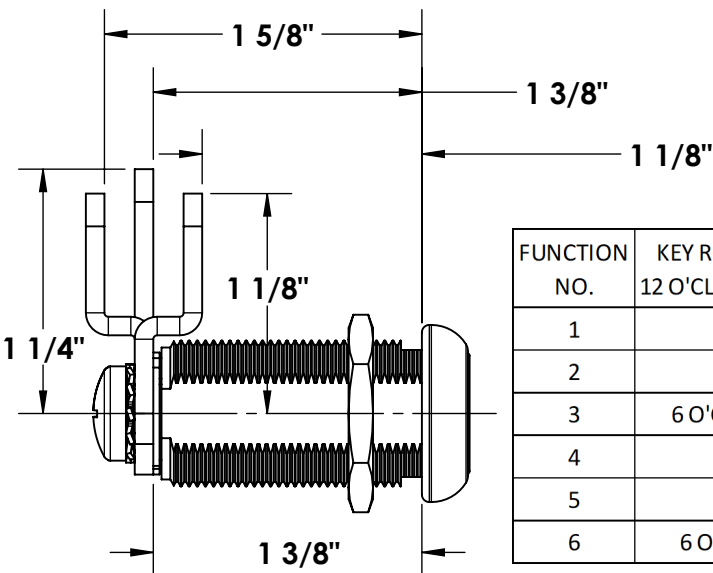
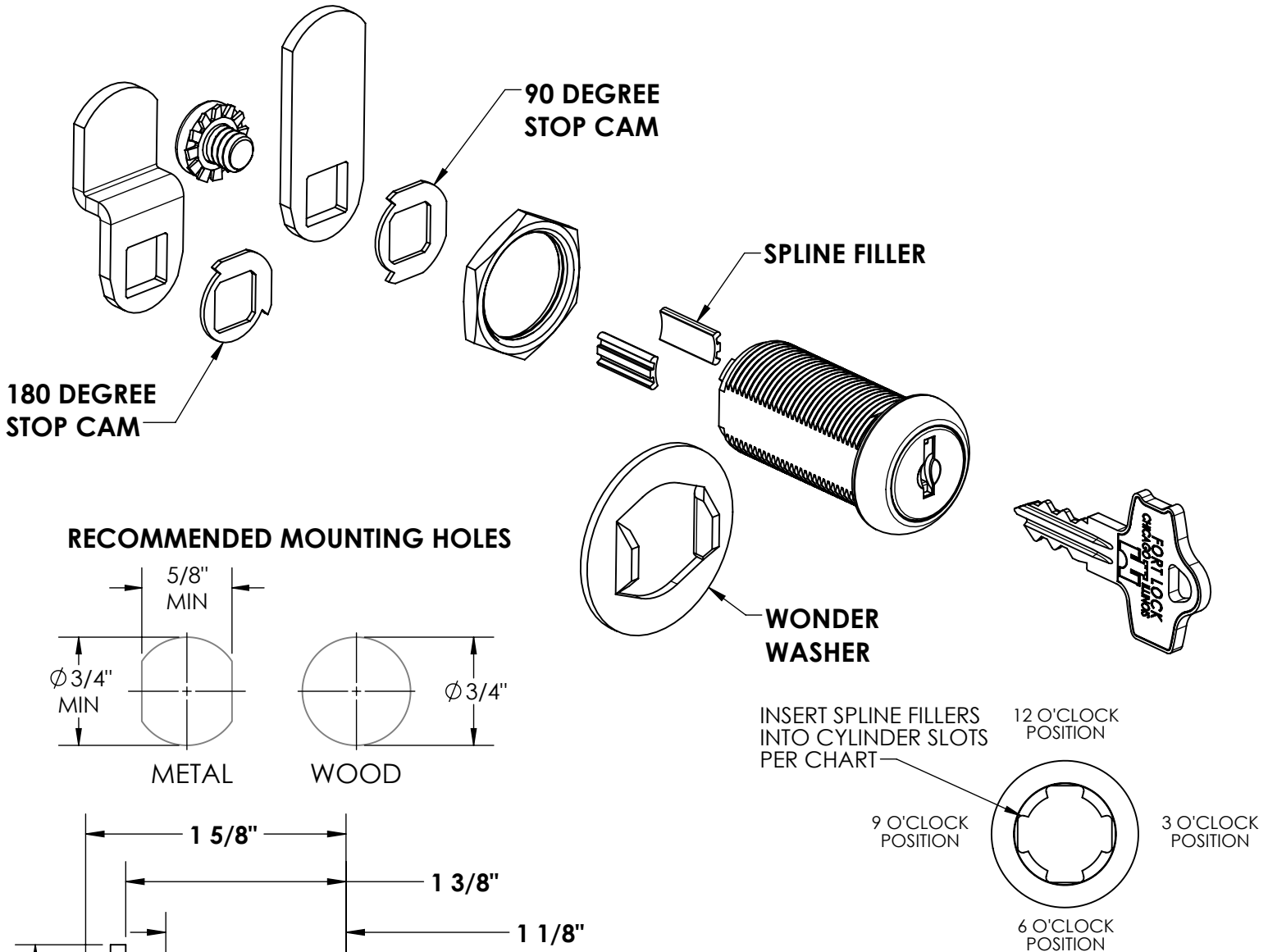

FUNCTION NO.	KEY ROTATION FROM 12 O'CLOCK POSITION TO	KEY REMOVABLE AT	USE CAM STOP	INSERT SPLINE FILLER AT
1	3 O'CLOCK	12 O'CLOCK ONLY	90 DEG RIGHT	3 O'CLOCK
2	3 O'CLOCK	12 AND 3 O'CLOCK	90 DEG RIGHT	NONE
3	6 O'CLOCK (RIGHT)	12 AND 6 O'CLOCK	180 DEG RIGHT	3 O'CLOCK
4	9 O'CLOCK	12 O'CLOCK ONLY	90 DEG LEFT	9 O'CLOCK
5	9 O'CLOCK	12 AND 9 O'CLOCK	90 DEG LEFT	NONE
6	6 O'CLOCK (LEFT)	12 AND 6 O'CLOCK	180 DEG LEFT	9 O'CLOCK