

CompX
SECURITY PRODUCTS



**COMPX IGNITION
AND SECURITY
SOLUTIONS**

FEATURES



- ◆ Triple sealed
- ◆ Corrosion Resistant Finish
- ◆ Standard or Custom Terminal Configuration
- ◆ Optional Starter lock out
- ◆ Operating range of -40 to 185°F
- ◆ 125 Key Codes

- A Highly Engineered Design -

CompX ignition switches satisfy the toughest customers in the roughest environments with superior performance, reliability and feel. Our long-standing position as a vertically integrated market leader in the security industry gives us the ability to engineer, tool, test, and manufacture to its customers exact specifications.

- Greater Simplicity -

CompX ignition switches bring the added value of a completely integrated lock system to this market for the very first time. Ignition switch and compartment locks can be tied together with a single custom key – further maximizing security and operational simplicity.

Key options include custom designed shapes, branding and over molding with brand logo. The key will become a proud symbol of ownership among end users because of the high levels of security, convenience and value it represents.

CompX Ignition Switches are triple sealed, making them extremely resistant to dust, water, ice, snow, salt, power wash, chemical sprays and more. A variety of corrosion resistant finishes not only extend switch life in tough environments, they also provide and enhance aesthetic quality.

As part of CompX's commitment to its customers, every switch is tested to environmental extremes. In addition, the availability of multiple key codes brings your products to the next level of security.

CompX can customize ignition switches and compartment locks in literally any way required.

CompX's experience is only matched by the fortitude of our people and engineers. We have the capabilities to take customers' equipment to the state-of-the-art in security and convenience – representing a value the end users can see and feel.

OPTIONS

- Distinct accessory position
- Start lock-out
- Head and mounting configuration
- Protective plating
- Terminal type
- Magneto ground terminal
- Key type and custom over mold

MAGNETO GROUND CIRCUIT



There are several features that set the Magneto Ground Circuit apart from other ignition switches. First, the terminals are insert molded which provides consistent positioning thereby increasing the reliability of electrical contact.

Next, our torsion spring enhances return reliability reducing the possibility of switch failure. Lastly, the switch is triple sealed to provide excellent water and environmental resistance.

SINGLE KEY SOLUTION

CompX also manufactures mechanical locks that are commonly found throughout the vehicle.

This flexibility allows the manufacturer the ability to provide the added convenience of a single key solution for the end user's security needs. Additionally, custom over molded keys are available, and will provide brand identity, and pride in ownership.



Ignition



Glove Compartment



Entry door



DESIGN SPECS

Switch Type: Battery Ignition and Start

Rating: 50 Amp @ 12VDC (50,000 cycles)

Standard Positions: Off Ignition Start

Start Features: Momentary Start with optional mechanical lockout

Detent: Positive system w/o axial movement

Bushing Type: 1" diameter 1-32UN-2A thread (32 threads/in.)

Mounting Hole: Optional configuration

Case Material: Zinc die cast with protective plating

Panel Thickness: Up to .25" (optional washer filler)

Plating Options: Various

Terminal Type: Quick Connect Terminals or Custom

Ground Terminal: Optional

Terminal Material: Brass

Connector Type: Packard Electric #56

Base Material: Glass Filled Nylon

Actuator: Coded tumbler lock, 2 keys

Lock Tumbler: Removable core

Key Type: Optional

Key Code(s): 125

Key Logo: Overmold, Incised, Laser Etched

Seals: Dual stem seal O-ring sealed terminal insulator

Life Cycle: 50,000

Pressure Spray: 1,800 psi @ 6" for 30 sec.

Operating Temp: -40 to 85°C (-40 to 185°F)

Vibration: Tested @ 12 g

Distinctive ignition keys reinforce owner pride and build brand identity.

SPECIFICATIONS

Three positions:
off - on - start

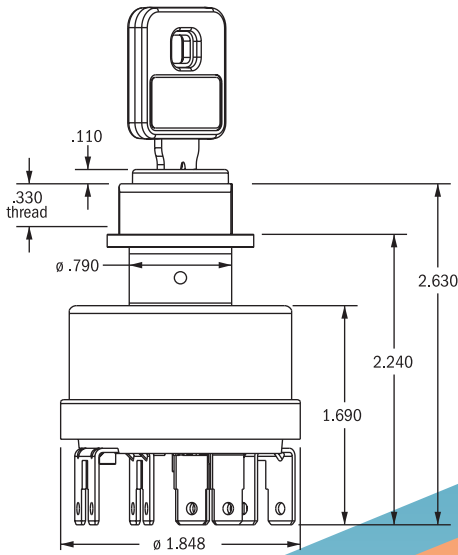

INTEGRATED CONNECTORS

Recommended mounting hole size

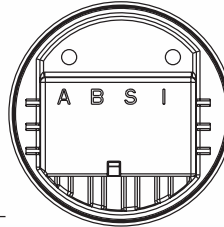
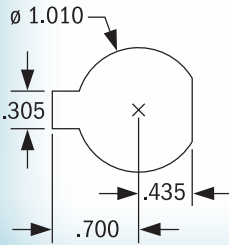

4 terminals
Packard 630
Series Connector

Four positions:
off - accessories - on - start

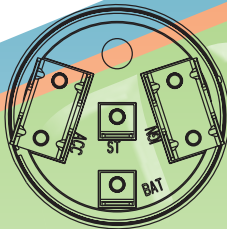
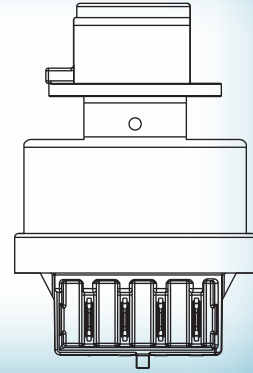

10 terminals
Packard 56
Series Connector

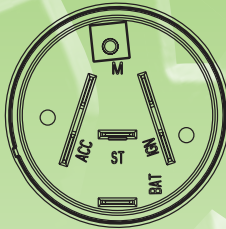

7 terminals
Packard 56
Series Connector

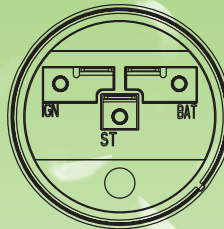

3 terminals
Packard 56
Series Connector

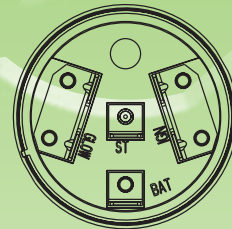

6 terminals
Packard 56
Series Connector

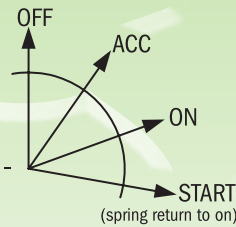
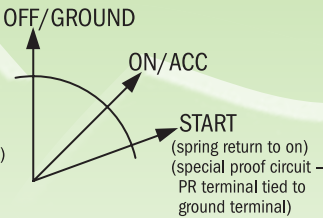
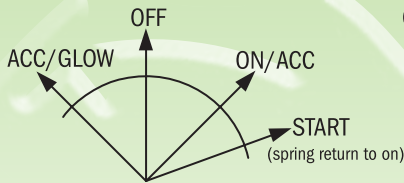

Recommended mounting hole size

