

C8178 DRAWER LOCK

- 4 pin tumbler
- brass cylinder

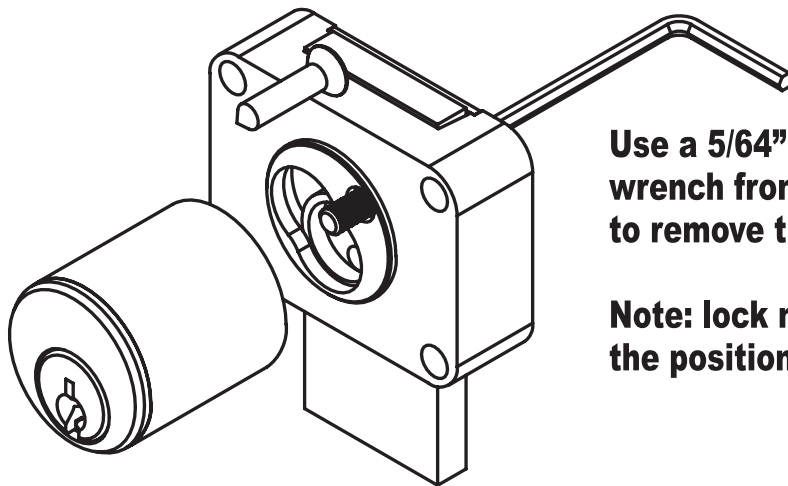
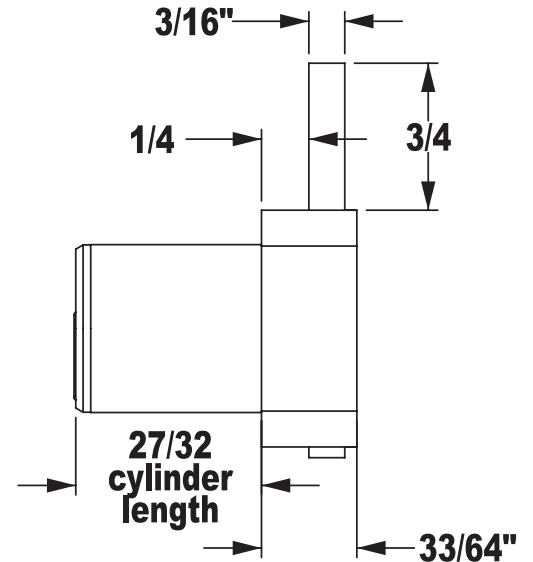
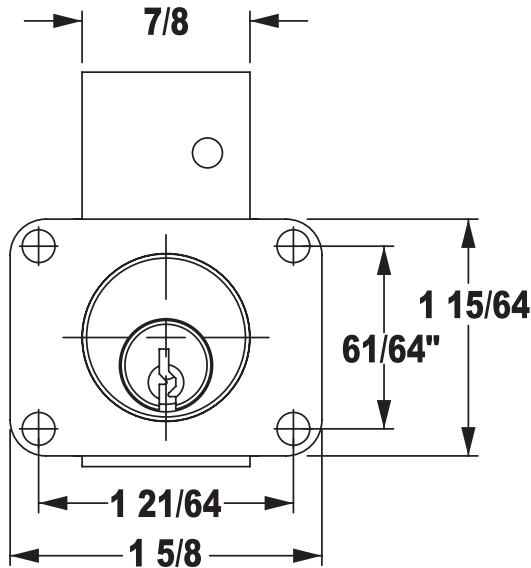

Use a $5/64$ " Allen wrench from the back to remove the cylinder.

Note: lock must be in the position shown.

cylinder mounting hole

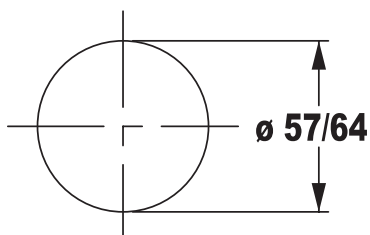

Drill $1/16$ " diameter pilot holes for mounting screws

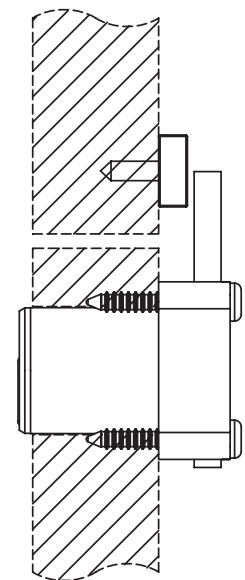

Lock is shown in locked position for standard drawer applications.