

## C8113 CAM LOCK

- 4 PIN TUMBLER
- 1 3/16" CYLINDER LENGTH
- FOR LIPPED APPLICATIONS

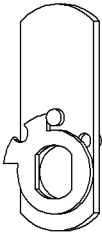
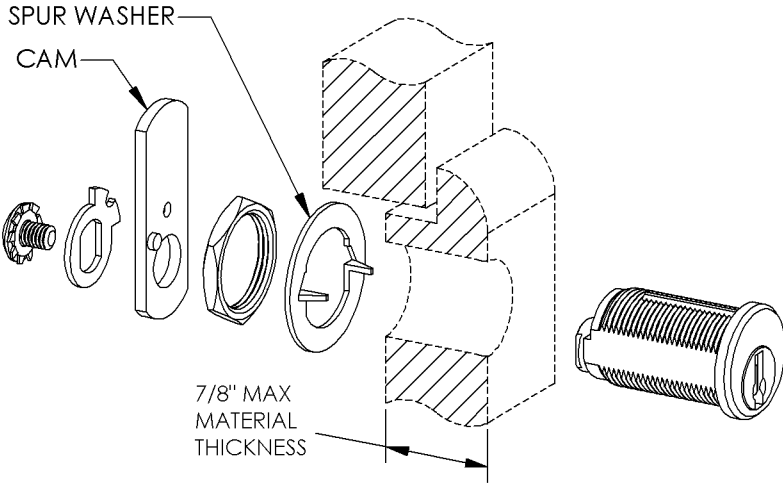

ASSEMBLED WITH  
CAM FOR L.H. DOOR  
OR CW DRAWER USE

NOTE: CAMS ARE NOT  
REVERSIBLE



EXTRA CAM FOR  
R.H. DOOR OR  
CCW DRAWER  
USE

### CYLINDER MOUNTING HOLES

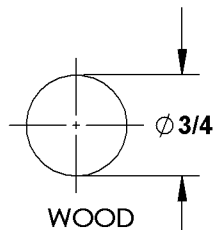
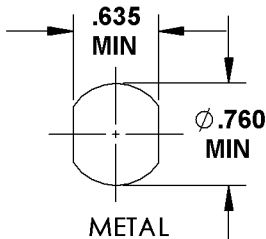

NOTE: DO NOT USE SPUR WASHER WITH METAL DOOR OR DRAWER